



HYDROTOP
WORKS

MONTAGEHANDLEIDING

Hydrocap HC-serie

Versie 1.0 14-10-2020

	uitvoeren door:	
stap	opdrachtgever	HydrotopWorks
1	●	
2		●
3		●
4		●
5		●
6		●
7	●	
8	●	

1 Raveling en voorzieningen

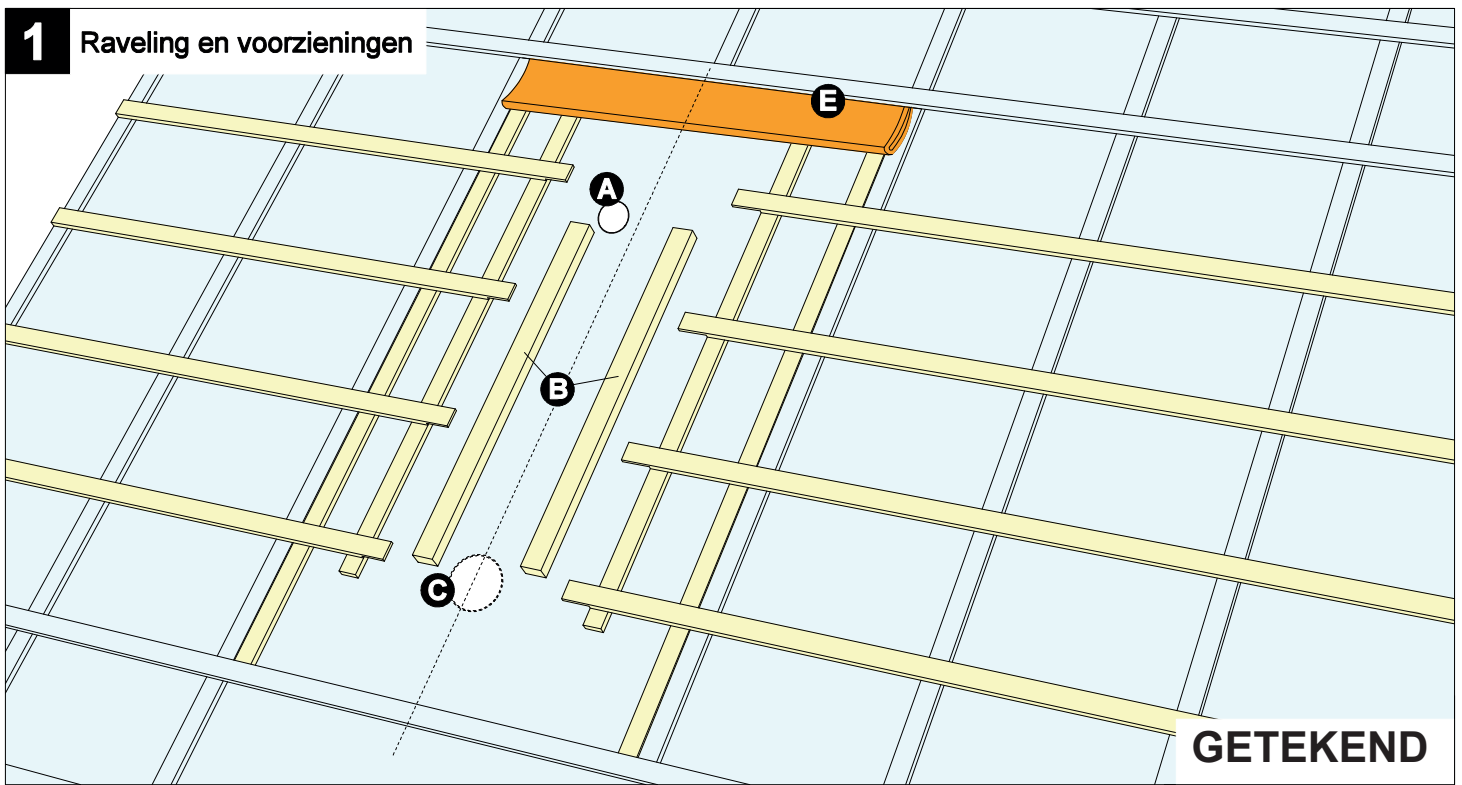

Door opdrachtgever te verzorgen:

- A. Sparring PVC $\varnothing 110$ (loodrecht)
- B. Regels 44x70 lang 1200 mm (los/vast op kap meeleveren)
- C. Sparring PVC $\varnothing 200$ (loodrecht) (alleen indien optie gekozen)
- D. Ondersteuning 18 mm multiplex op regels/klossen volgens opgave constructeur
- E. Slabbe mandragende folie tot in gootstuk

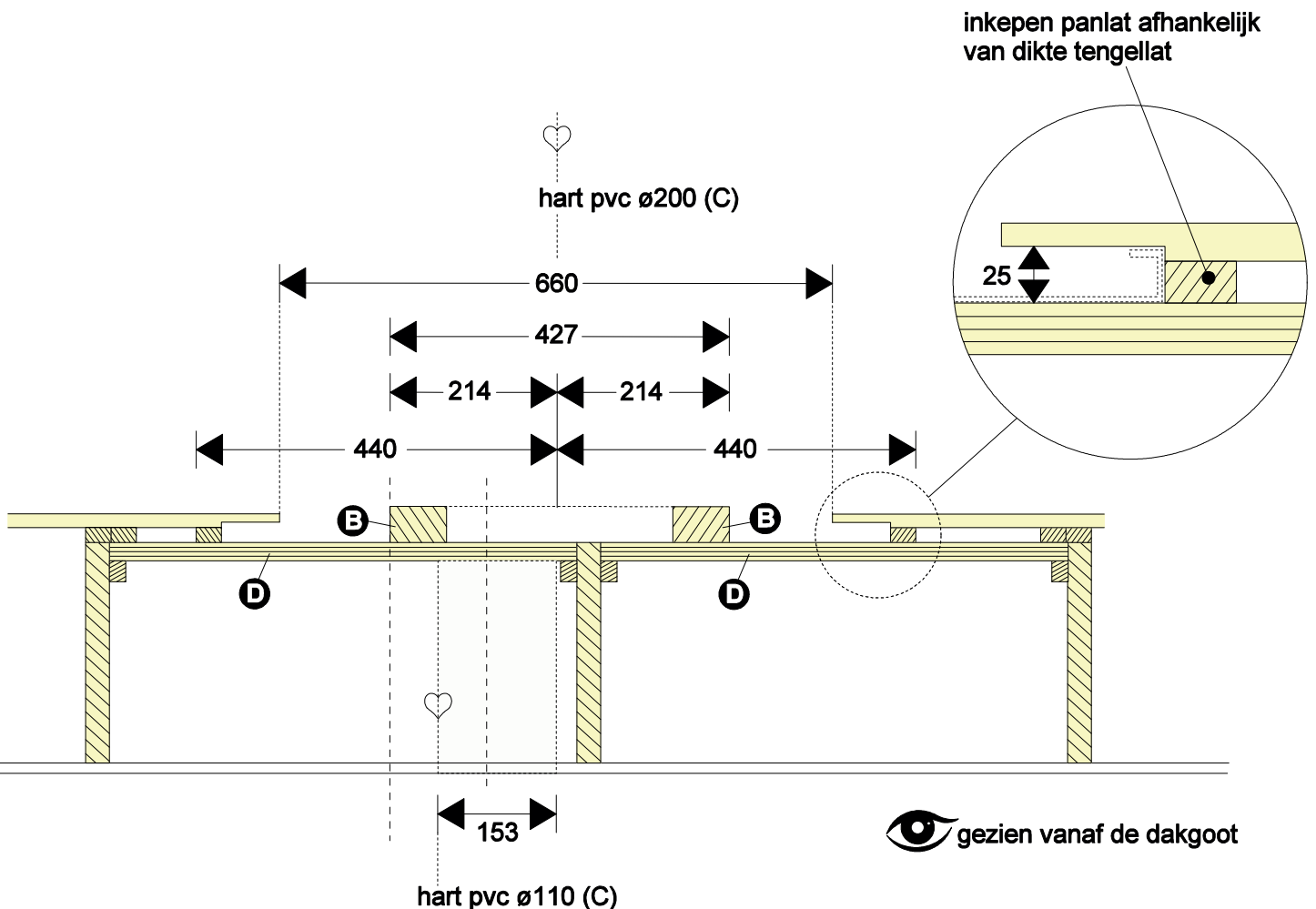

1 Raveling en voorzieningen

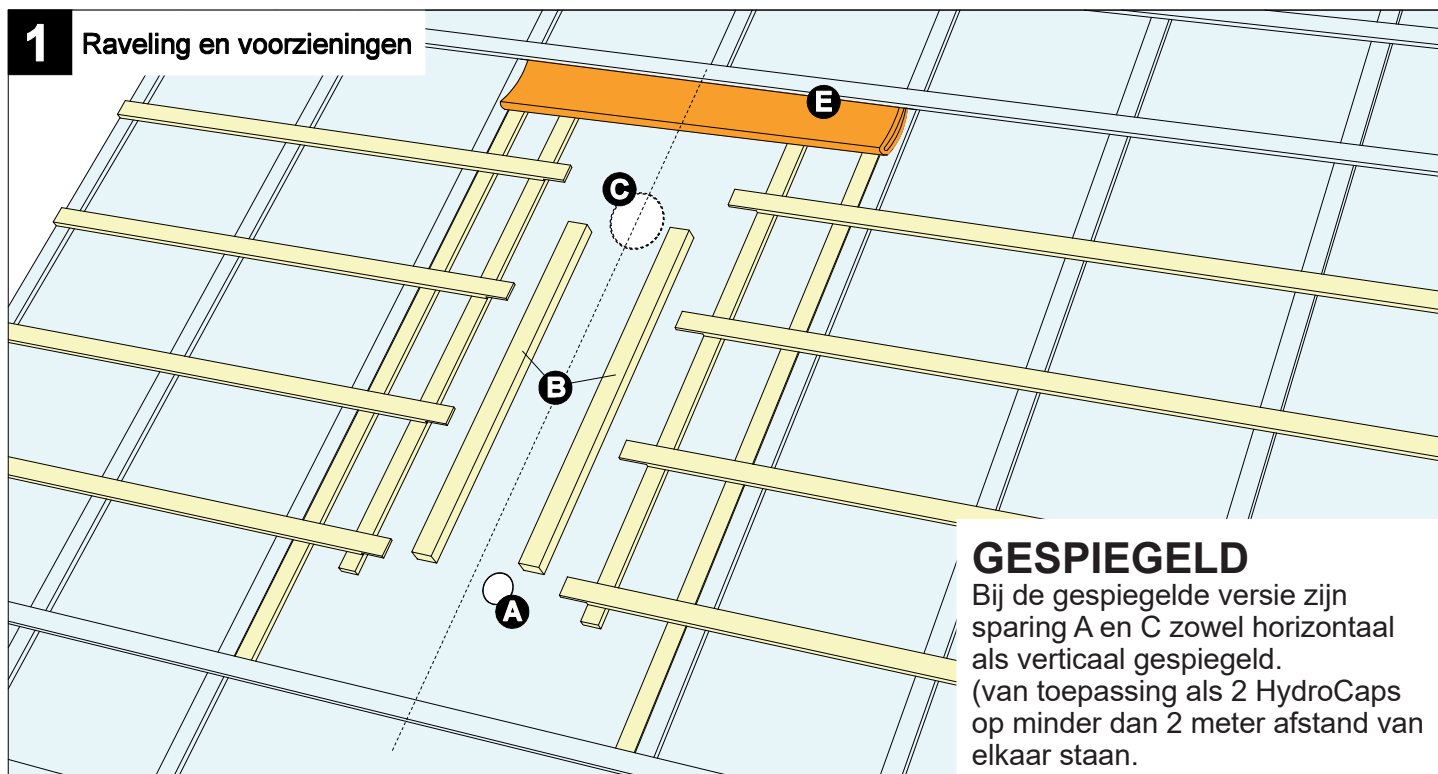

Door opdrachtgever te verzorgen:

- A. Sparing PVC $\varnothing 110$ (loodrecht)
- B. Regels 44x70 lang 1200 mm (los/vast op kap meeleveren)
- C. Sparing PVC $\varnothing 200$ (loodrecht) (alleen indien optie gekozen)
- D. Ondersteuning 18 mm multiplex op regels/klossen volgens opgave constructeur
- E. Slabbe mandragende folie tot in gootstuk

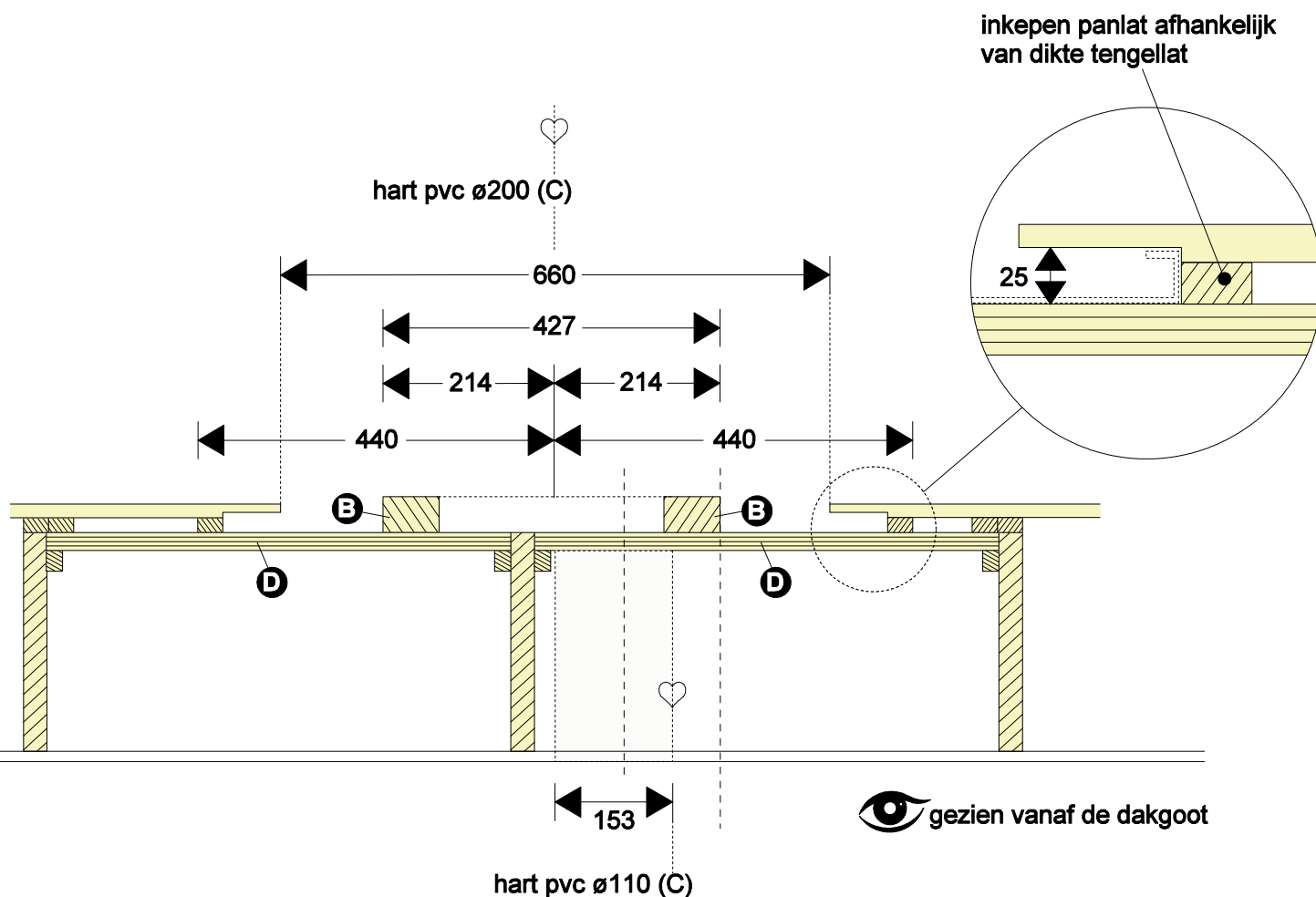

2 Verwijderen regels 44x70 + 'inscheppen' gootstuk

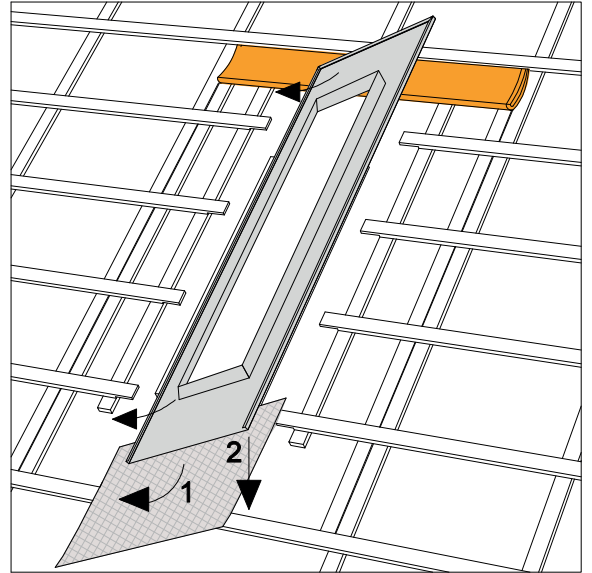
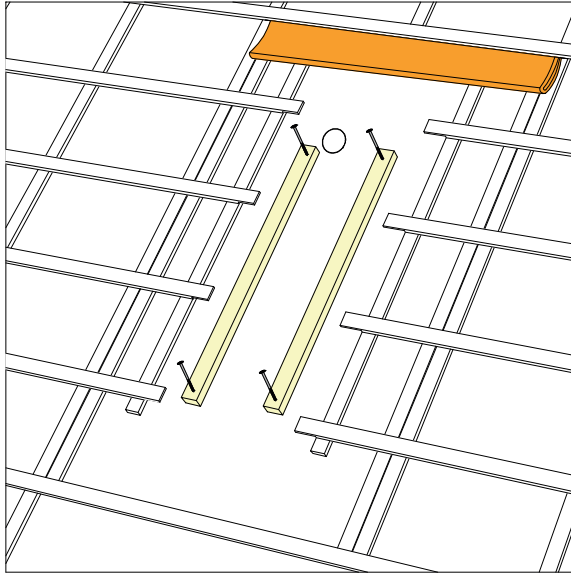

3 Aanbrengen gootstuk

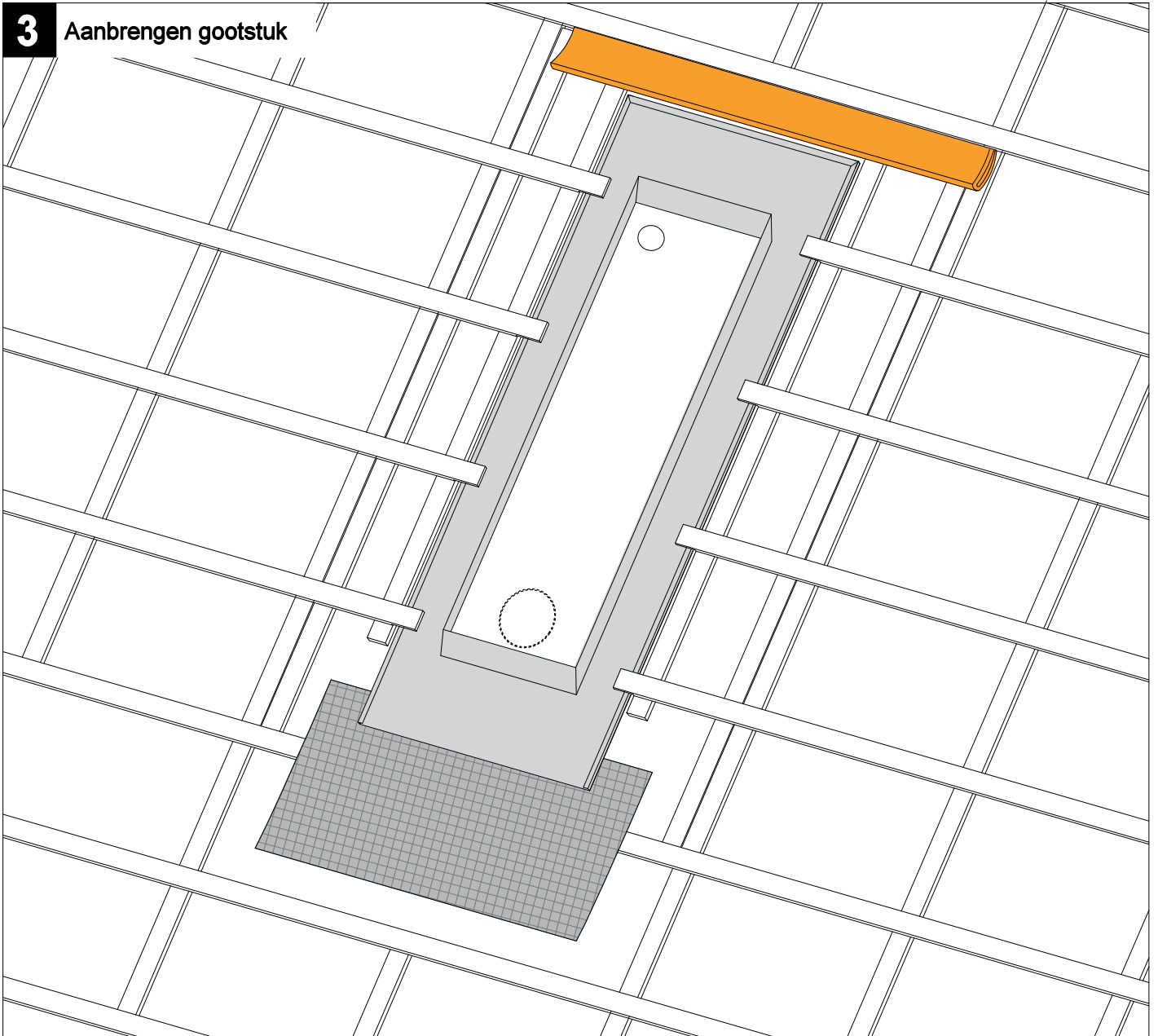

4 Vastzetten regels + gootstuk

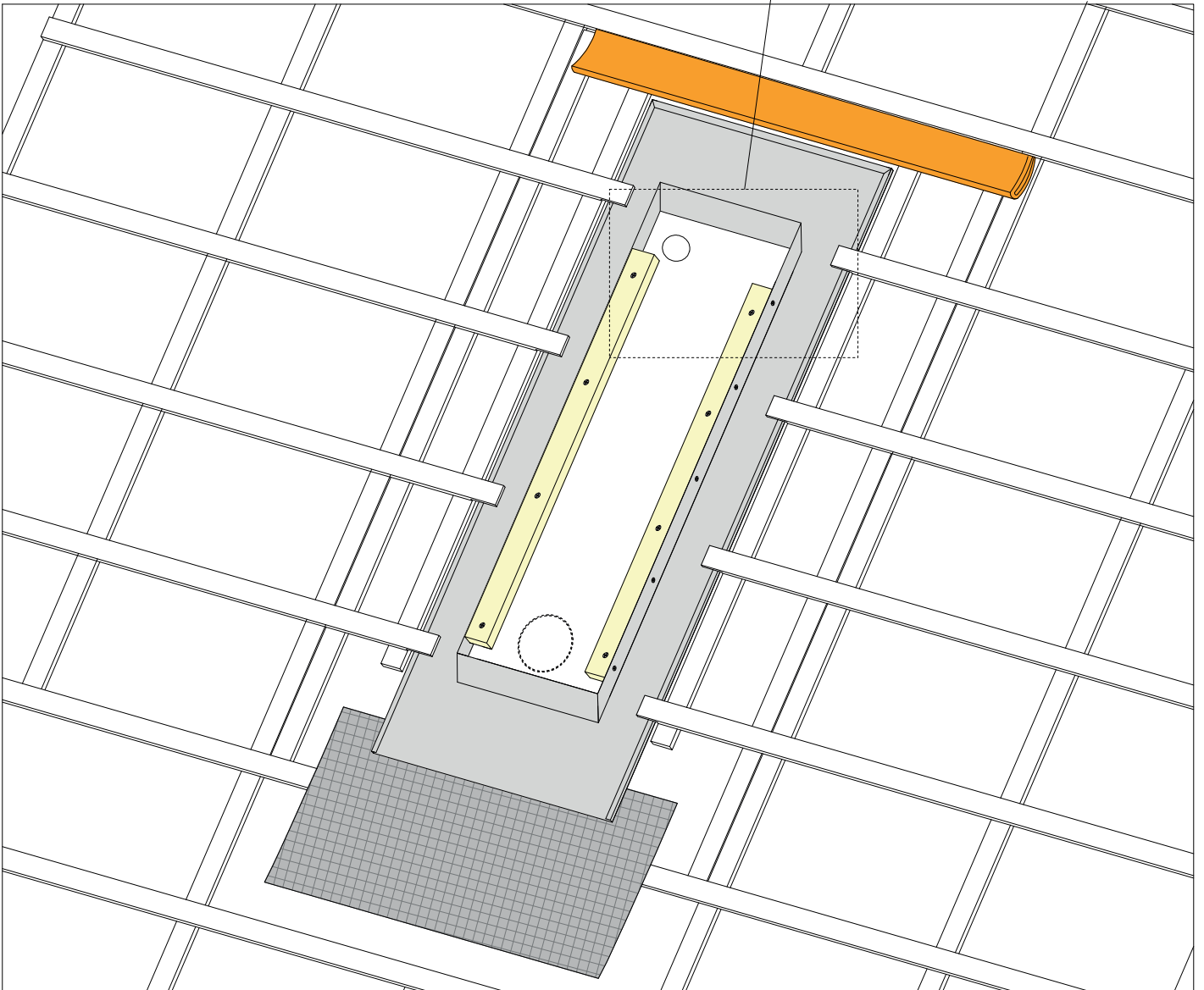
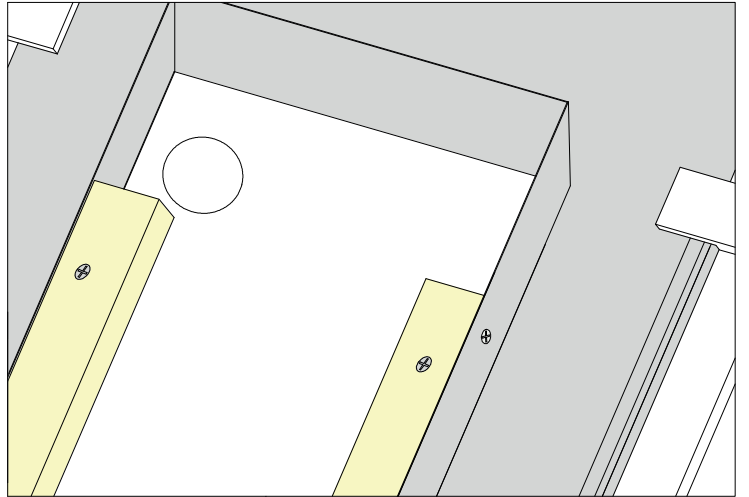
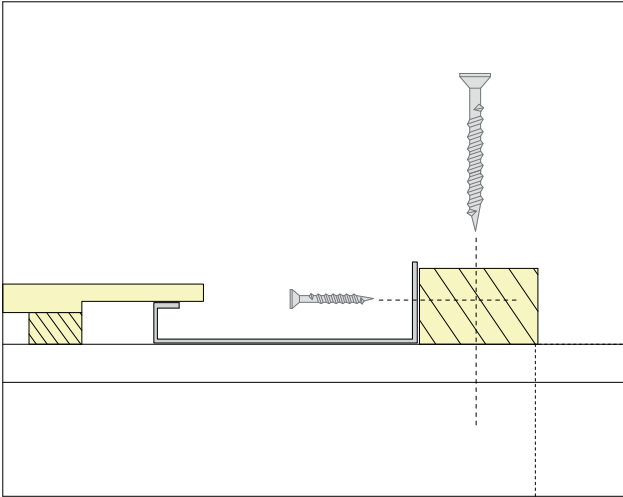

5 HydroCap middels hijsvoorziening op het dak zetten

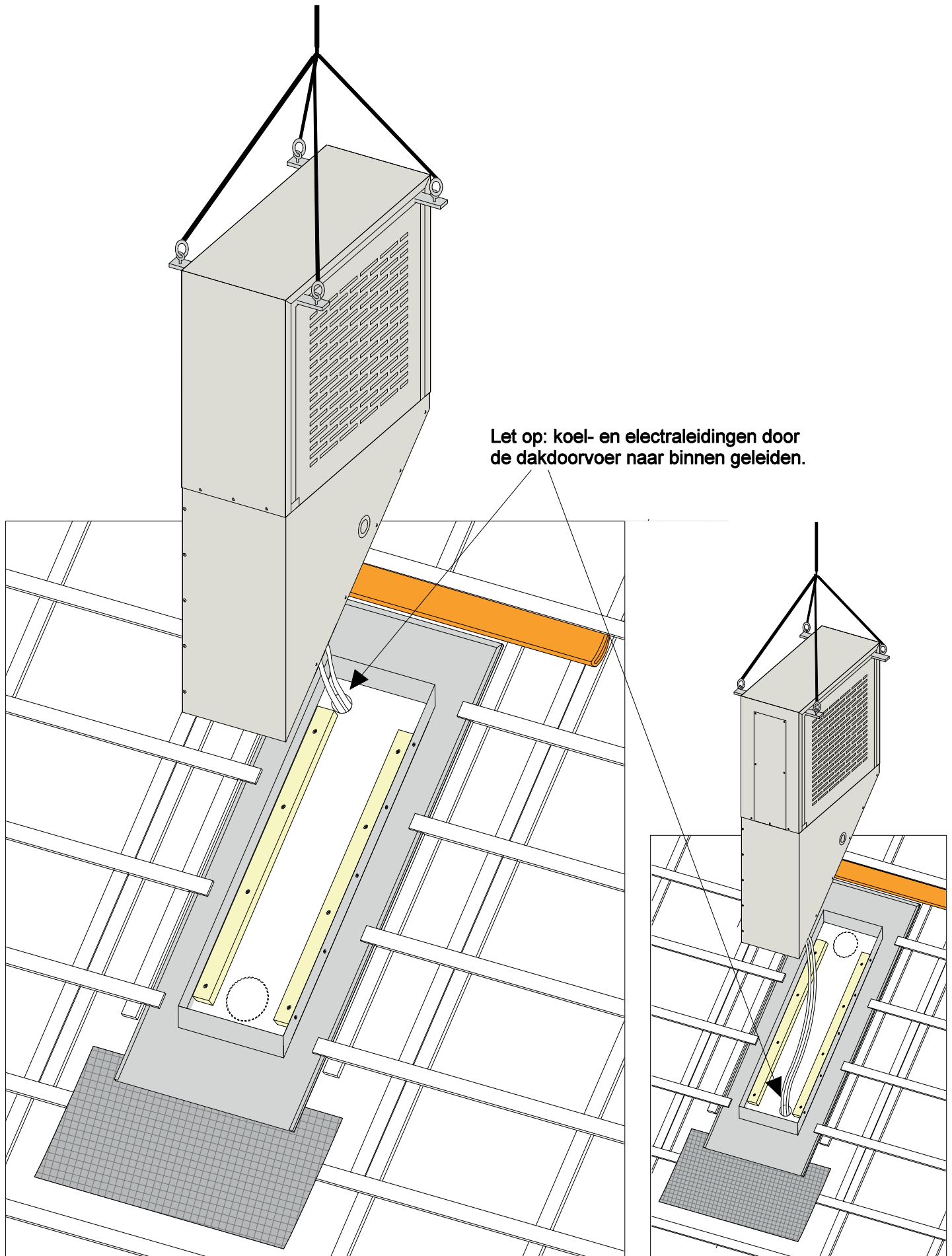

GETEKEND

GESPIEGELD

6 HydroCap vastzetten aan gootstuk

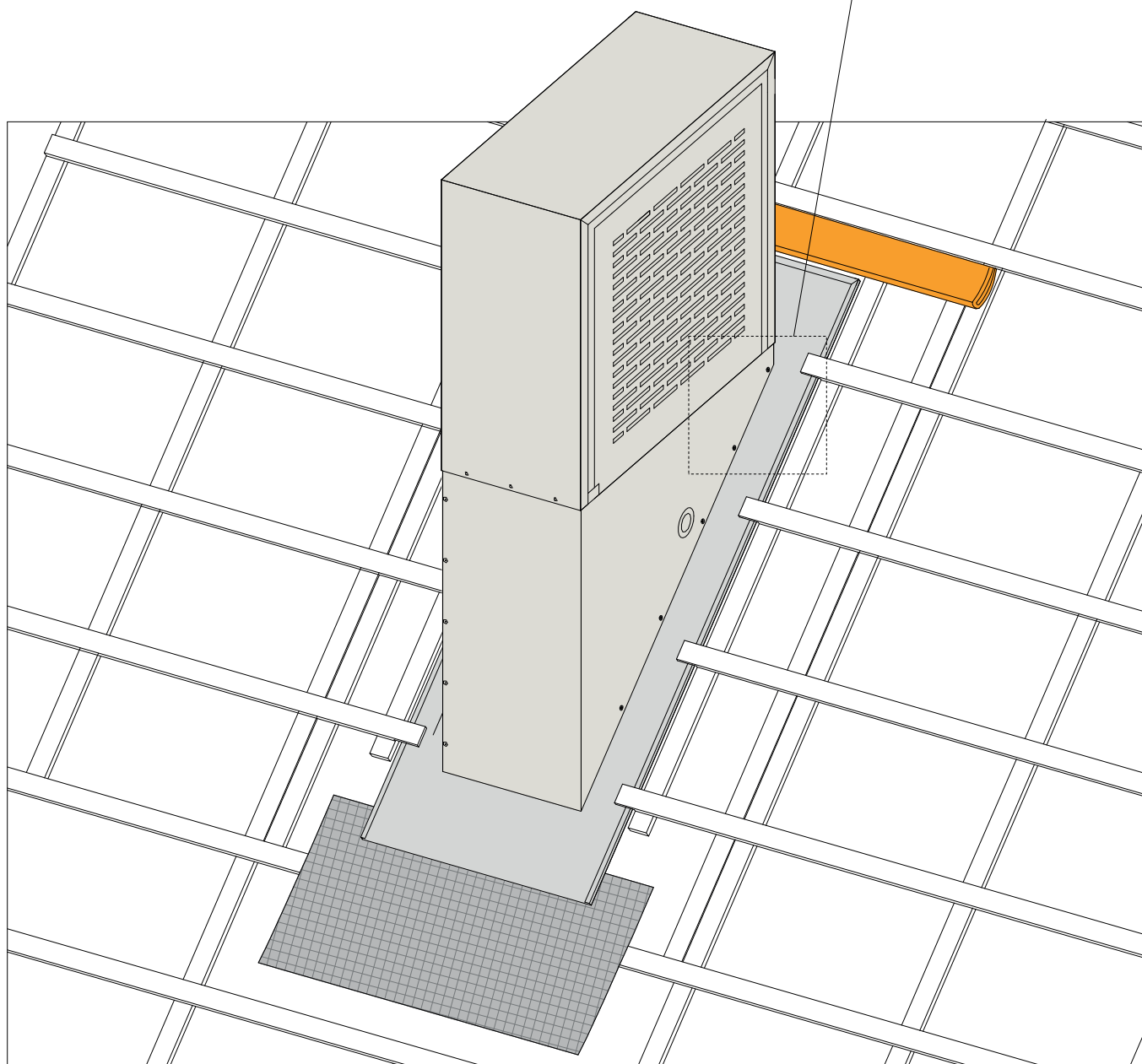
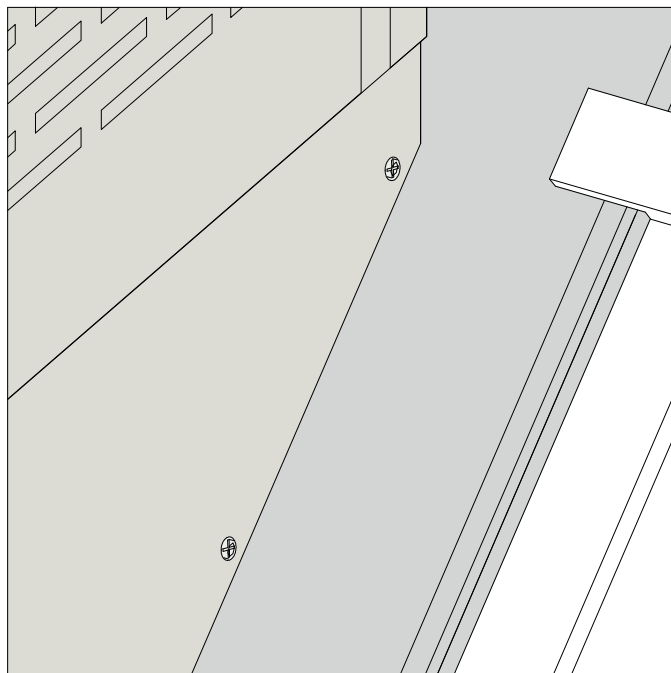

7

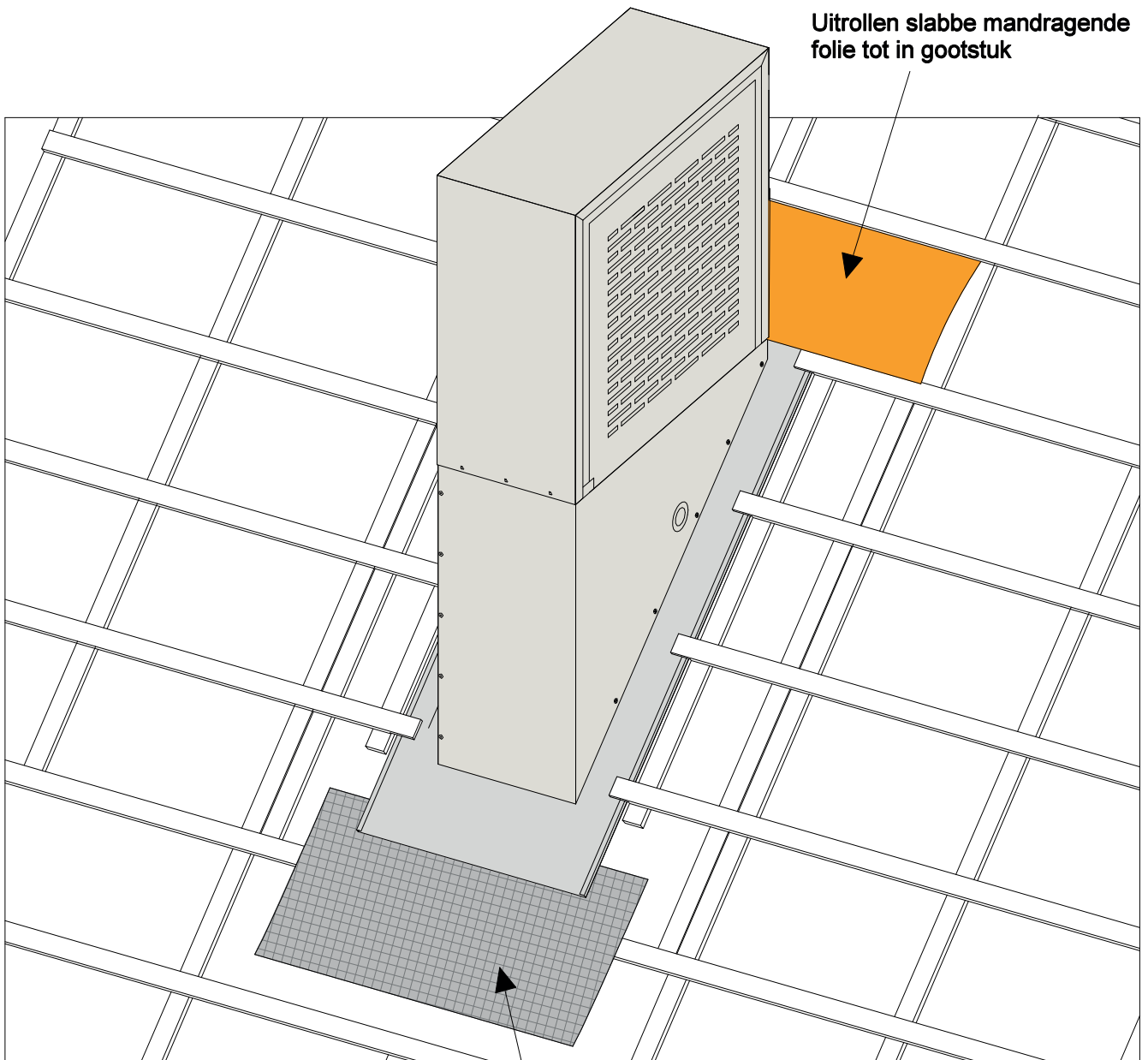

8

Afwerking binnenzijde

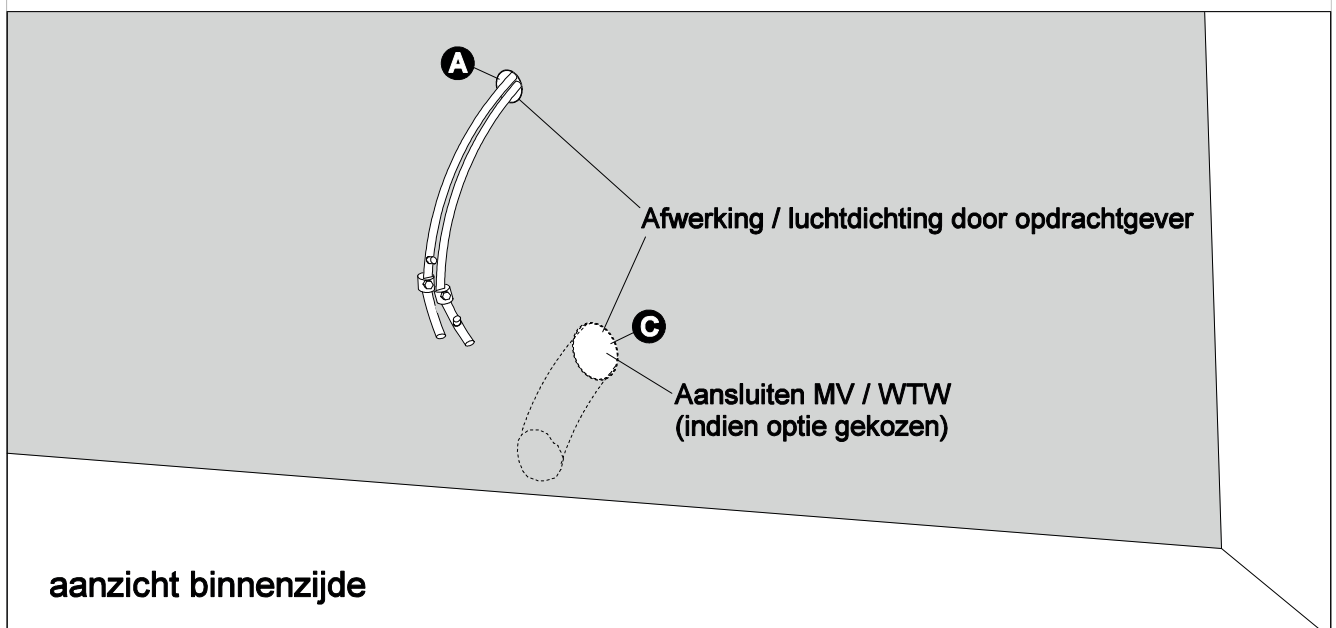

Verwijder de bouten om de deuren te kunnen openen voor onderhoud of reparatie.

